

Cervical Cancer

Diagnostic/staging evaluation should include:

- Pelvic examination: Per speculum and pervaginal examination
- CBC, LFTs, renal function
- CXR
- CECT abdomen +pelvis

Treatment:

Stage I A1

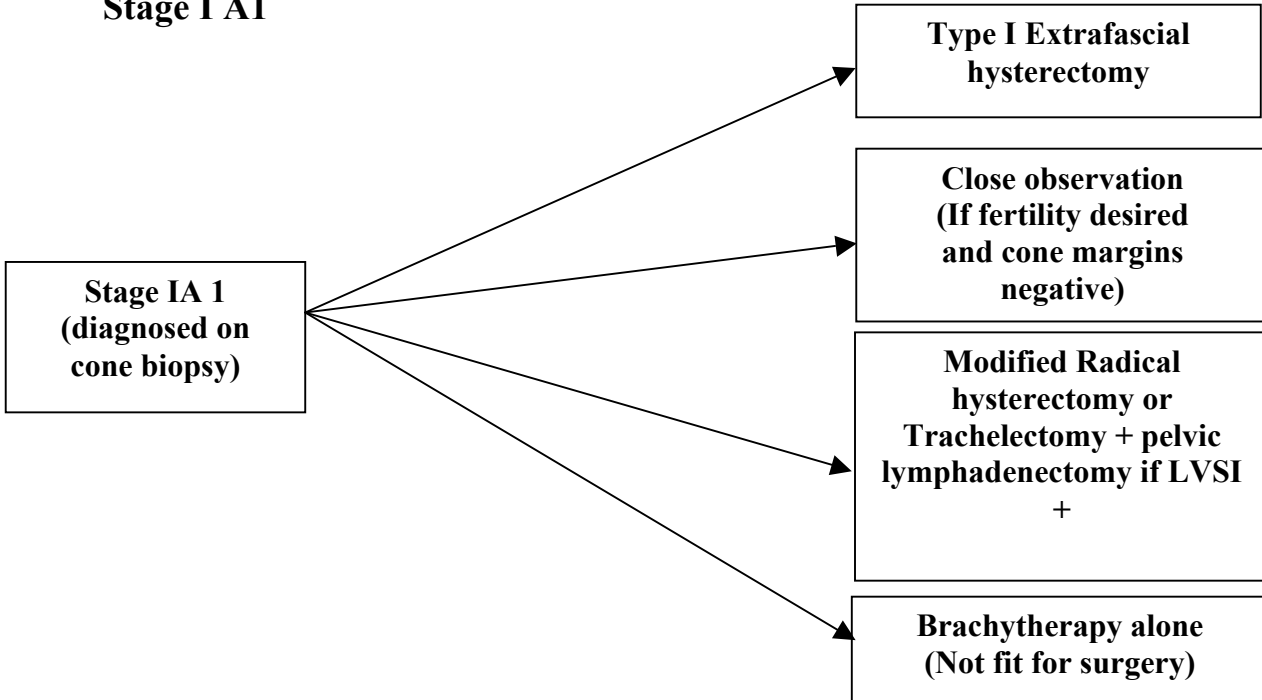

Stage I A2

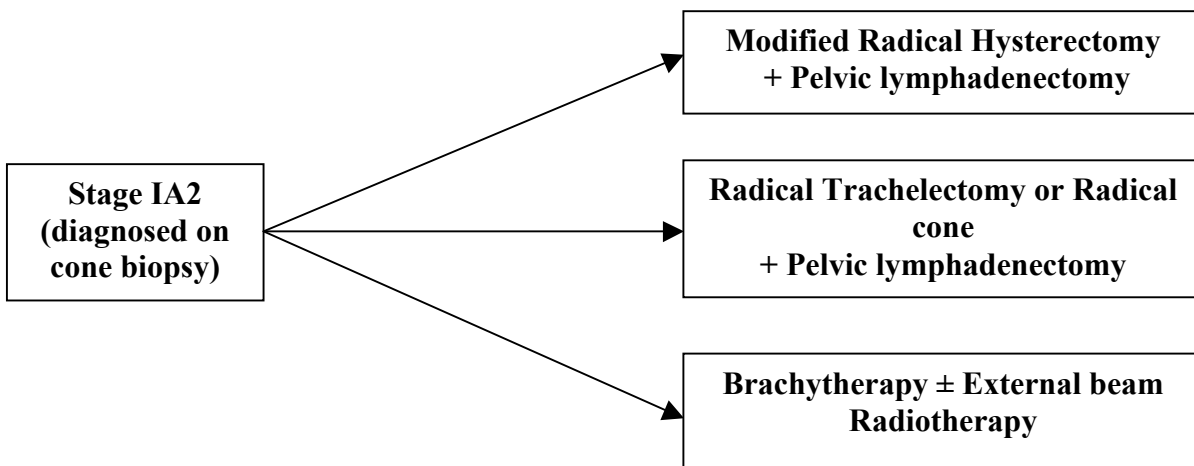

Stages IB1 and IIA1

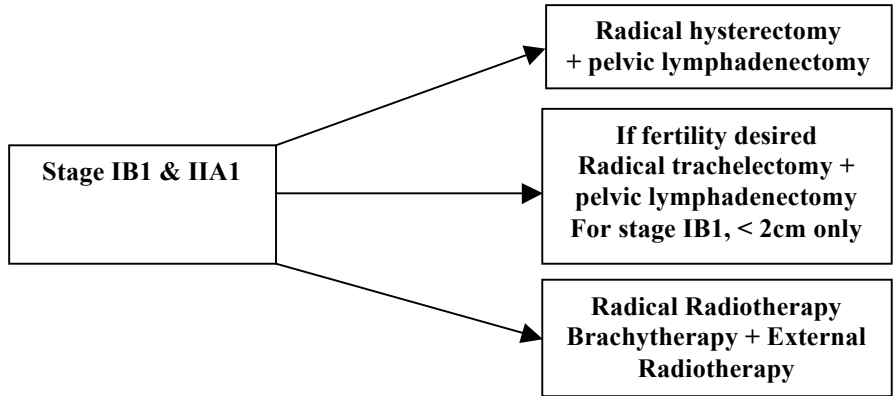

Stages IB2 and IIA2

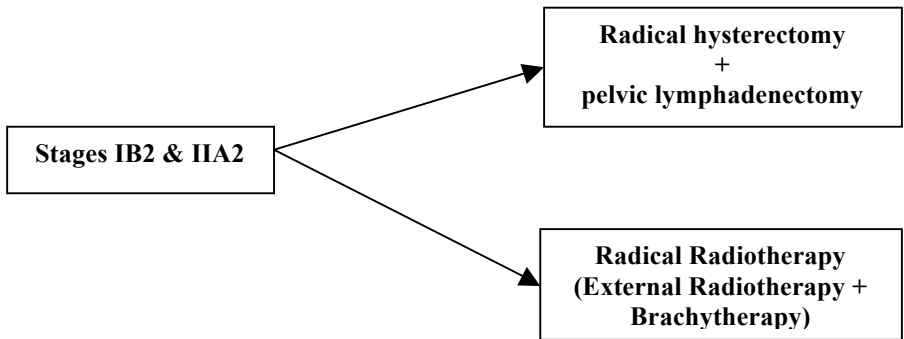

Adjuvant treatment after Radical surgery

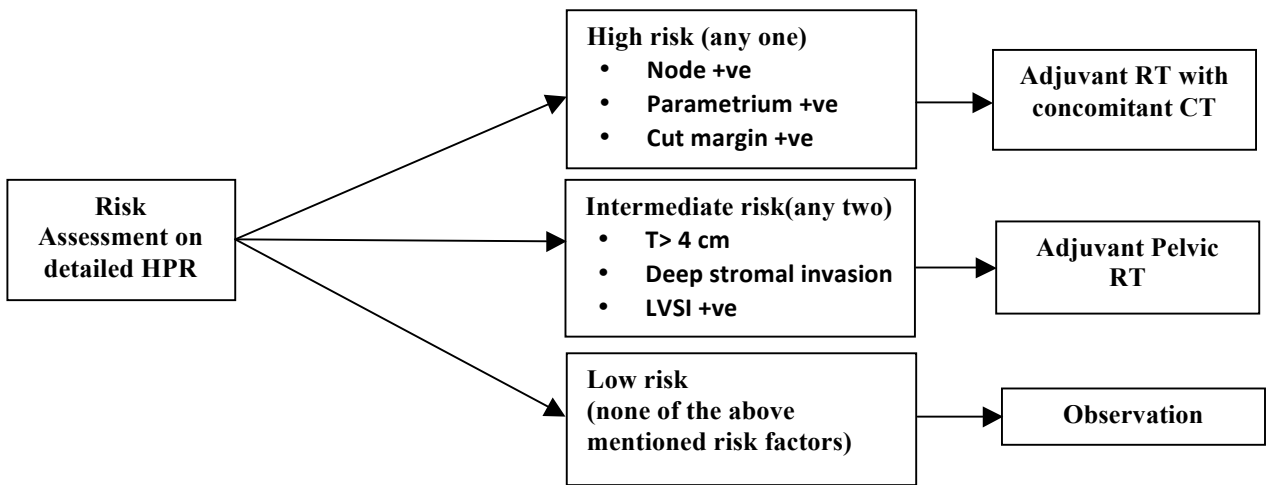

Stage IIb and III

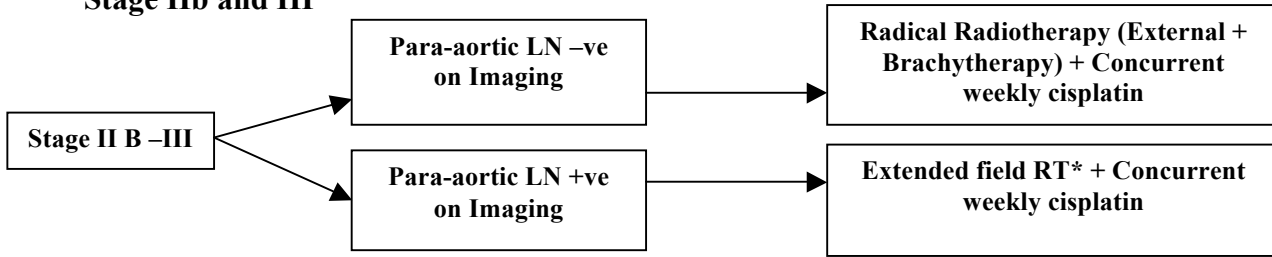

Stage IV

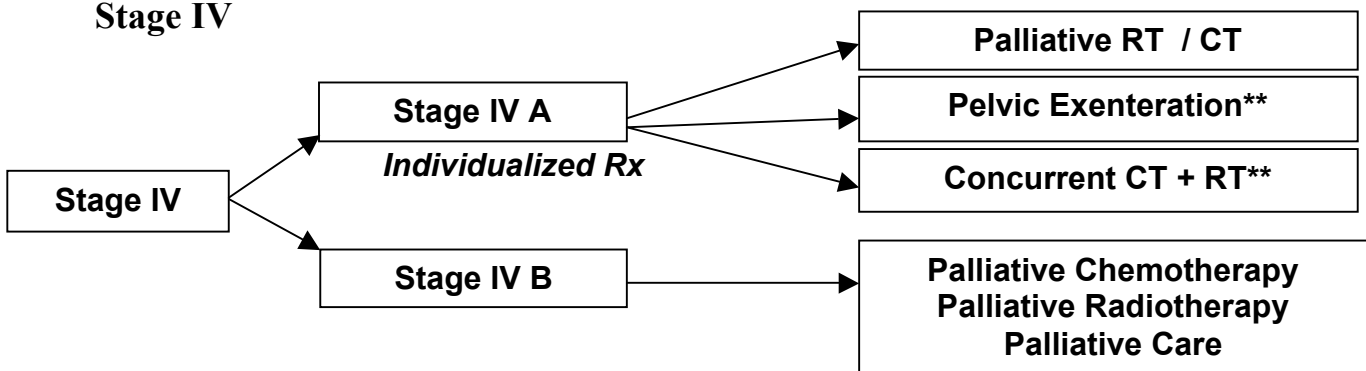

** Select cases